



**PLYMOUTH**

Suddenly, it's 1960... **3 full years ahead** ... the only car that dares to break the time barrier!



# Suddenly, it's 1960... 3 years ahead... with Plymouth's new Torsion-Aire Ride and sports car handling!

**SMOOTHEST RIDE YET!** Plymouth's Torsion-Aire Ride comes from an utterly new way of building cars and brings you comfort which words cannot convey. You'll have to drive it to believe it! Plymouth's revolutionary new suspension system seems to out-think the road, adjusting softly and instantly to keep the car always level and cushioned. Up front in Plymouth, two torsion bars of enormously strong, springy high chrome steel smother bumps before they reach the car's frame, divert jars direct to big, new Oriflow shock absorbers.

**SPORTS CAR HANDLING!** This amazing new Plymouth handles and "corners" with the safety, ease and steadiness of a costly sports car, thanks to Torsion-Aire Ride. There's no sway or roll, even on brisk turns. You stop without uncomfortable "nose dive." Torsion-Aire Ride actually uses a car's own dynamic forces to keep your riding level and super-smooth. In the 1960-new Plymouth, the center of gravity is lower to handle tremendous new power. Here are engineering advances a full 3 years ahead of the industry!

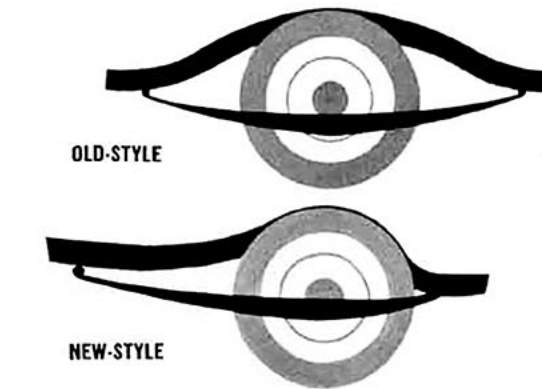

← **1960-NEW REAR SPRINGING.** Rear springs are longer, mounted off-center . . . (Picture shows the difference.) No jounce when you apply brakes on bumps! Plymouth's new rear springs are "outrigger" mounted for super-stability.

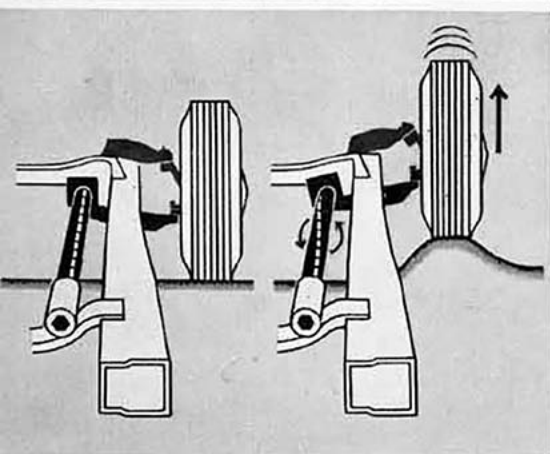
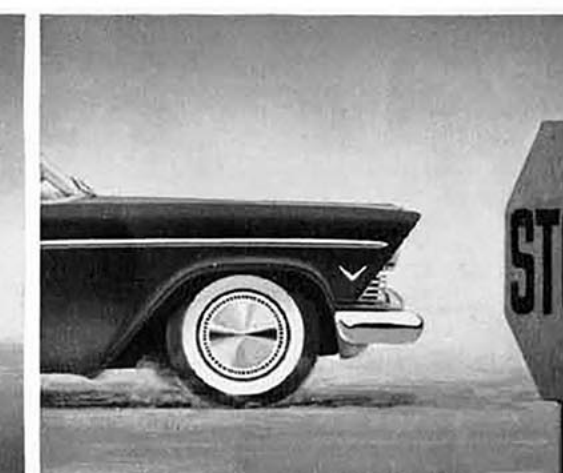

**1960-NEW TORSION BARS.** When the new Plymouth goes over rough roads, powerful torsion bars twist, and thus absorb bumps before they can reach the car's frame. Keeps your car riding smooth and level.



**1960-NEW SAFETY POWER CHASSIS** with a 3-inch longer wheelbase. And only a long wheelbase can give you such luxury riding. Frame is huskier, stronger, wider, 15 inches longer. New full-length Safety-Y construction for stronger support of bumpers. Gives body more rigidity. Extra cross member provides greater safety. Live rubber mountings help absorb vibrations, noise, and road shock.

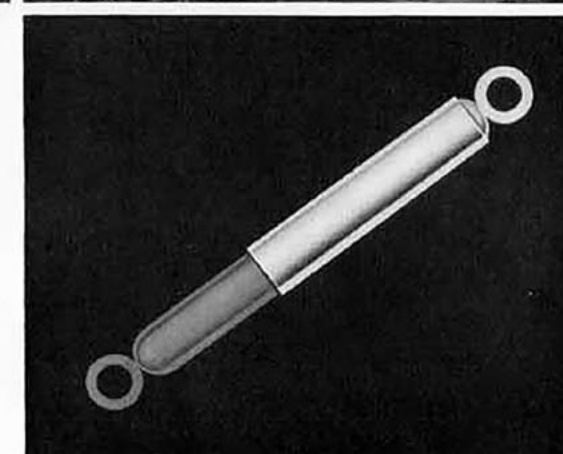

**1960-NEW ORIFLOW SHOCK ABSORBERS.** World's finest "shocks," only on Plymouth in the low-price 3, now larger and with still greater cushioning power. No other shock absorbers adjust so quickly, so exactly to all conditions.

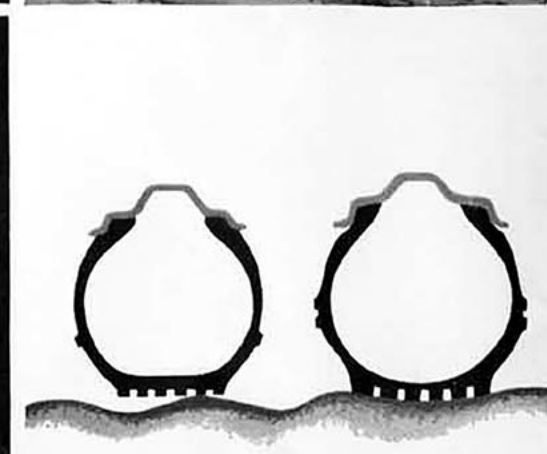

**1960-NEW EXTRA AIR CUSHIONING.** You ride on a 10% greater air volume in the new Plymouth! Wheels are smaller so that tires can be wider, softer, for better traction and smoother ride at high speed. Tires last longer.



← **1960-NEW BALL-JOINT CONTROL.** The most modern of its kind. It's new—1960-new! This part of the revolutionary Plymouth Torsion-Aire suspension system makes steering easier, steadier. And no matter how bumpy the road, your ride is always smooth. See how the right front wheel in picture is taking that big bump? Yet the frame and the rest of the car go along on an even keel. The car stays level. And you get no jounce or bounce.

**NO "NOSE DIVE" WHEN MAKING A SUDDEN STOP!**



**OLD-STYLE**

On "old" car, arrows show how the front noses down and the rear rises, for an uneasy, uncomfortable stop.



**NEW-STYLE**

1960-new construction of the Plymouth keeps car level even when you're making an instantaneous emergency stop.



## Luxurious Dream Car Interiors

Be prepared to gasp with delight when you first open the door of an exciting 1960-new Plymouth! Here you have a choice of modern, wear-resisting fabrics in an almost limitless combination of harmonious colors. Choose interiors for

your 1960-new Plymouth to express your own personality as surely as does your home! Plymouth interiors say "luxury" from the color-keyed, wall-to-wall carpets to the ultra-comfortable seats, functional lighting and insulated ceiling.



Engineered to handle tremendous new power!

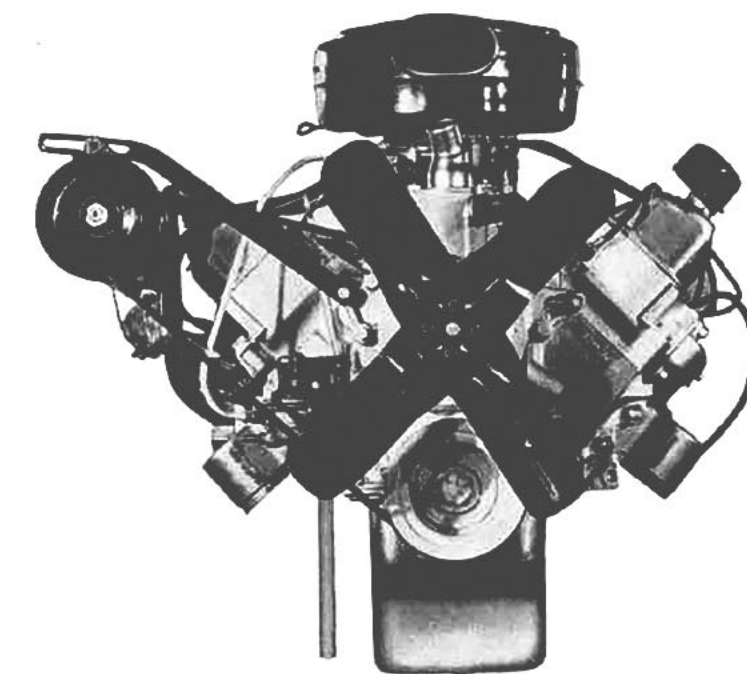

**PLYMOUTH ENGINEERS HAD TO DESIGN A WHOLE NEW CAR TO HANDLE THE TERRIFIC POWER OF THIS MIGHTY NEW ENGINE!** Plymouth's fabulous new Fury "301" V-8 is one of the most rugged passenger car engines ever built. More power for safe response. Bigger displacement. A new, quieter camshaft. A new jet-flow carburetor. A new replaceable paper element air filter makes it all but impossible for any dirt to enter the engine—ever!



**1960-NEW PUSH-BUTTON DRIVING.** This important Plymouth "first" in the low-price 3 is a positive mechanical control. Now driving is as easy as touching a doorbell. Amazing new Torque-Flite 3-speed automatic transmission is now optional in V-8 Belvedere and V-8 Sport Suburban models. PowerFlite available on all models.

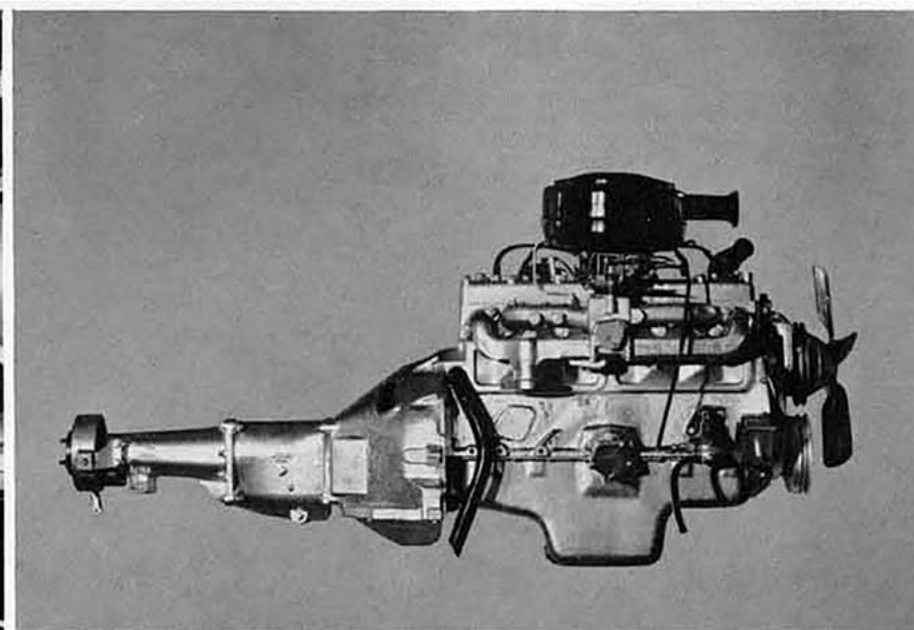

**1960-NEW POWERFLOW 6!** Here is the most dependable "6" on the road today. And this year, it is more powerful than ever before. Easy to maintain . . . easy on gas and oil, it's the engine most taxi companies choose for durability and performance. More Plymouths are used as taxis than all other makes of cars combined.



**PLYMOUTH'S \$50,000,000 QUALIMATIC ENGINE PLANT** provides engineering excellence never before possible! Here, new Fury "301" V-8 engines are built automatically with aid of electronic brains. Imperfect parts are rejected automatically! These amazing machines even give engines trial runs, then score the results.

4 new lines of **Dream Cars**...with Flight-Sweep Styling...  
the new shape of motion!

THE **BELVEDERE** LINE

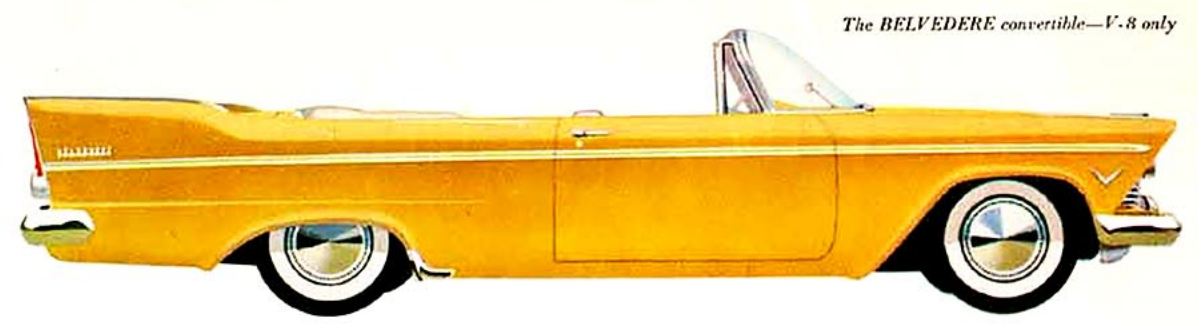

*The BELVEDERE convertible—V-8 only*

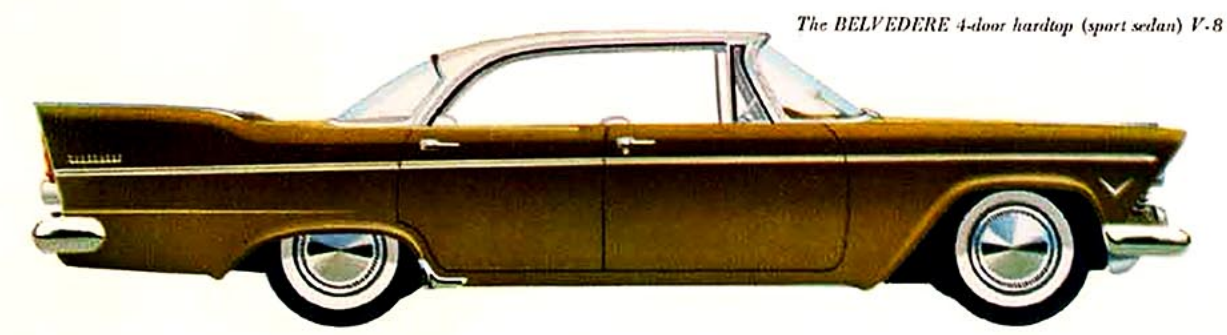

*The BELVEDERE 4-door hardtop (sport sedan) V-8 or 6*



*The BELVEDERE 2-door hardtop (sport coupe) V-8 or 6*



*The BELVEDERE 4-door sedan V-8 or 6*



*The BELVEDERE 2-door (club sedan) V-8 or 6*

THE **SAVOY** LINE

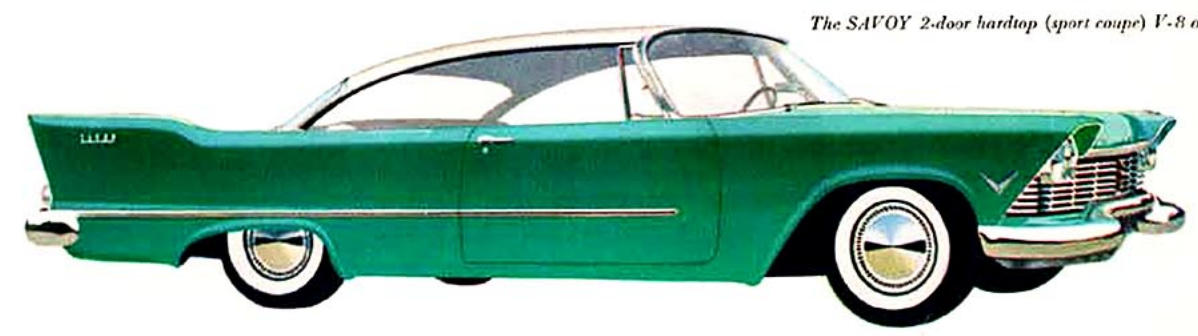

*The SAVOY 2-door hardtop (sport coupe) V-8 or 6*

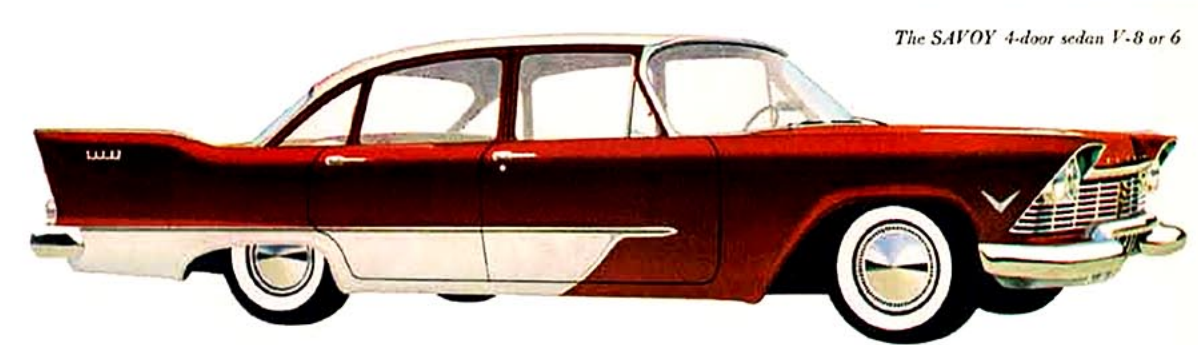

*The SAVOY 4-door sedan V-8 or 6*



*The SAVOY 2-door (club sedan) V-8 or 6*

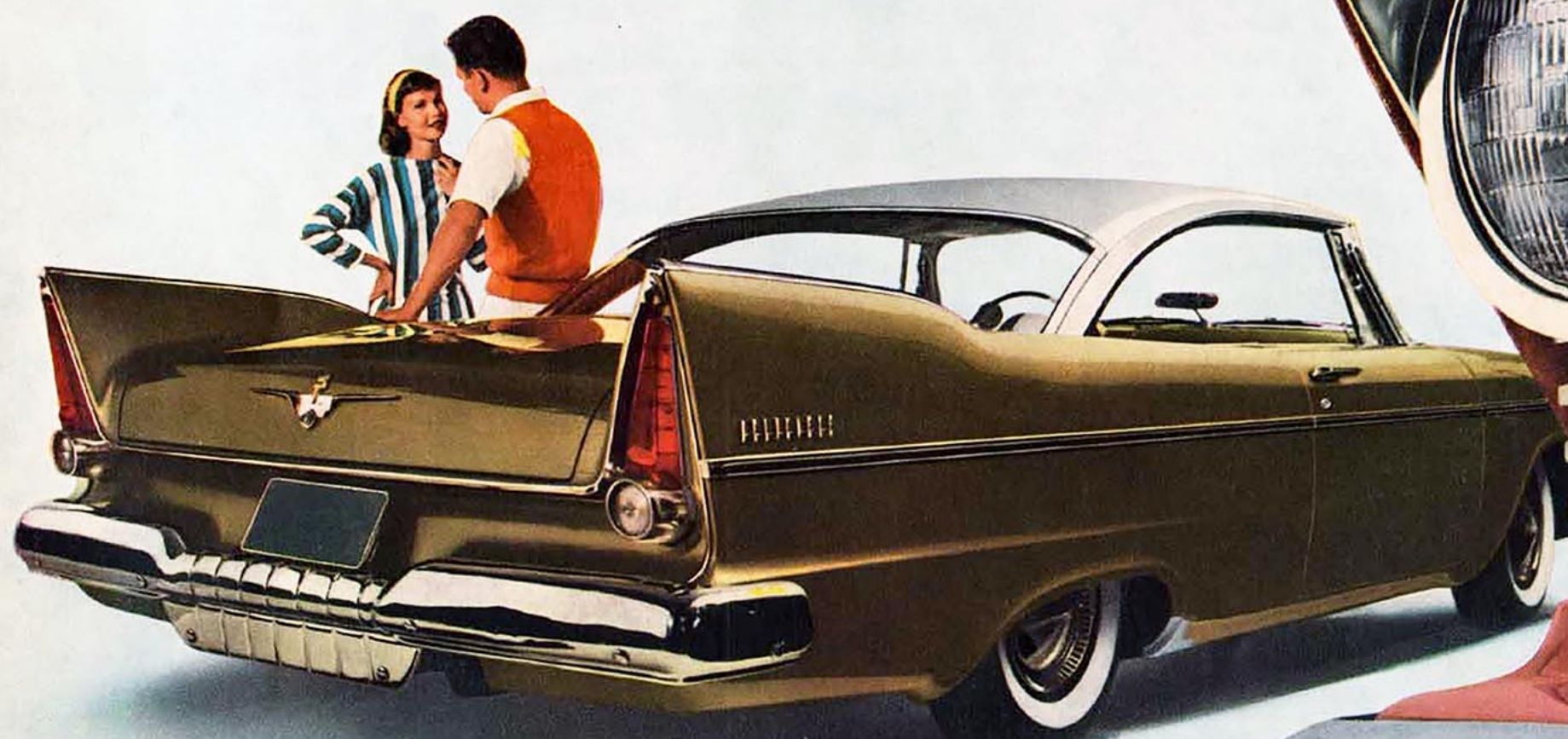

PLYMOUTH BELVEDERE 2-DOOR HARDTOP (SPORT COUPE)



## THE PLAZA LINE



The PLAZA 4-door sedan V-8 or 6



The PLAZA 2-door (club sedan) V-8 or 6



The PLAZA 2-door (business coupe) V-8 or 6

THE CARS YOU MIGHT HAVE EXPECTED IN 1960 . . . HERE NOW!

Cars are illustrated to show some items of special equipment such as trim, 2-tone paint, white wall tires, chrome bumper wing guards and wheel covers—all available at moderate extra cost.

Please ask your dealer for a copy of the special booklet with complete information about the great new Plymouth Suburbans.

## THE SUBURBAN LINE

The SPORT SUBURBAN 6 passenger or 9 passenger 4-door, V-8 or 6



The CUSTOM SUBURBAN 6 passenger or 9 passenger 4-door, V-8 or 6



The DE LUXE SUBURBAN 2-door V-8 or 6



The CUSTOM SUBURBAN 2-door V-8 or 6



**1960-NEW DOUBLE-HEADER HEADLIGHTS.** An exciting innovation in headlight styling. This extended beam unit throws light much farther, makes night driving safer. Safety Directional Signal Lights are now included on all 1960-new Plymouth models at no extra cost.



**1960-NEW LOUNGE CHAIR SEATS.** Firmly cushioned, for posture ease, the new seats are at the perfect height for pure riding comfort. You sit relaxed, as you do at home. Now 3 inches wider. Plymouth seats have spring construction that gives comfort you've never known before.

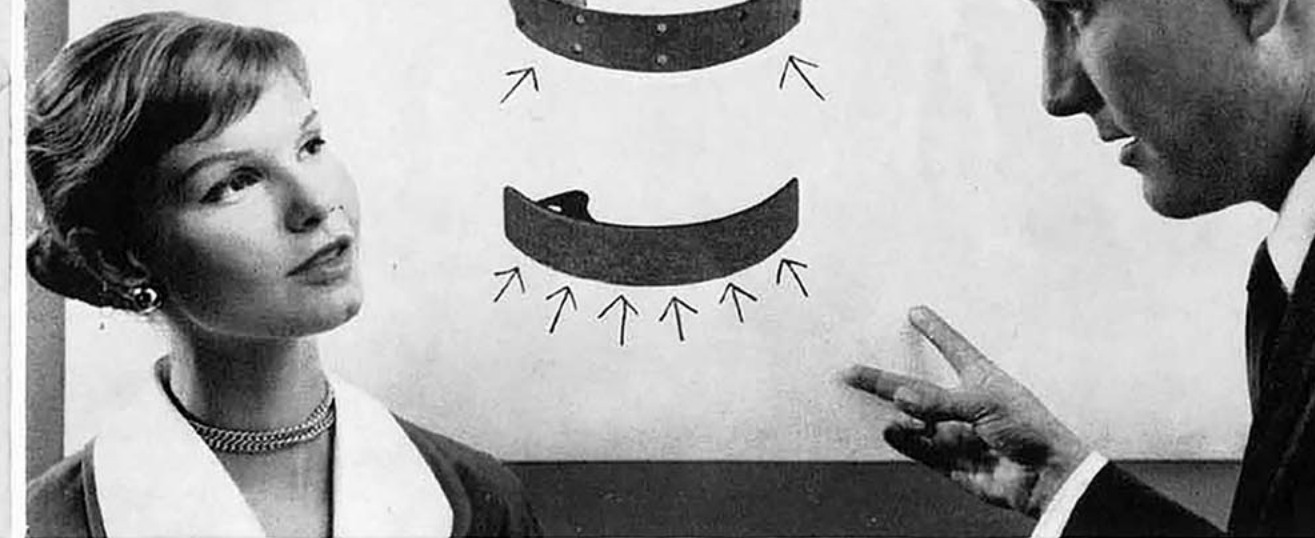

**1960-NEW TOTAL CONTACT BRAKES!** Exclusively Plymouth's in the field . . . new self-actuating and far more effective. They stop you better with one-quarter less pedal pressure. Linings last up to 30% longer. Adjustments are fewer. Arrows (top illustration) show how old-style brakes

grip mainly at each end. Plymouth's new Total Contact Brakes (bottom illustration) take hold with a sure, husky grip over the whole surface area. And lining area is increased with new 11 inch diameter brakes. Greater safety for a bigger Plymouth.

# Advances that make driving easier... safer... more luxurious!

**1960-NEW CONTROL TOWER VISIBILITY.** Riding in the fabulous Plymouth gives you a feeling of vast spaciousness. This 1960-new car provides up to 29% more glass area all around. Much wider, wrap-around windshield. More visibility overhead, too. Oversize electric windshield wipers clean a 38% wider area. And here's another

exciting Plymouth innovation that means better visibility . . . Swivel-mounted Defrosters located on top ledge of new cockpit-compact instrument panel, give you complete control of defrosting over the entire windshield. Aim them in any direction you choose. (Available with heater in all models.)

**1960-NEW INSTRUMENT PANEL AND ACCESSORIES!** Combining utility and striking new beauty, the Plymouth instrument panel groups the gauges in an easy-to-see cluster in front of the driver where he can observe them without taking his eyes off the road. All controls within easy reach for convenience and safety while driving. Among

Plymouth's optional power assists are Full-Time Power Steering . . . Power Brakes . . . Power Windows . . . and Power Seat. Also Plymouth All Weather Air Conditioner . . . cools, heats, dehumidifies fresh, clean air for perfect comfort all year round. Highway Hi-Fi Record Player and luxury "Search-Tune" Radio optional in all models.

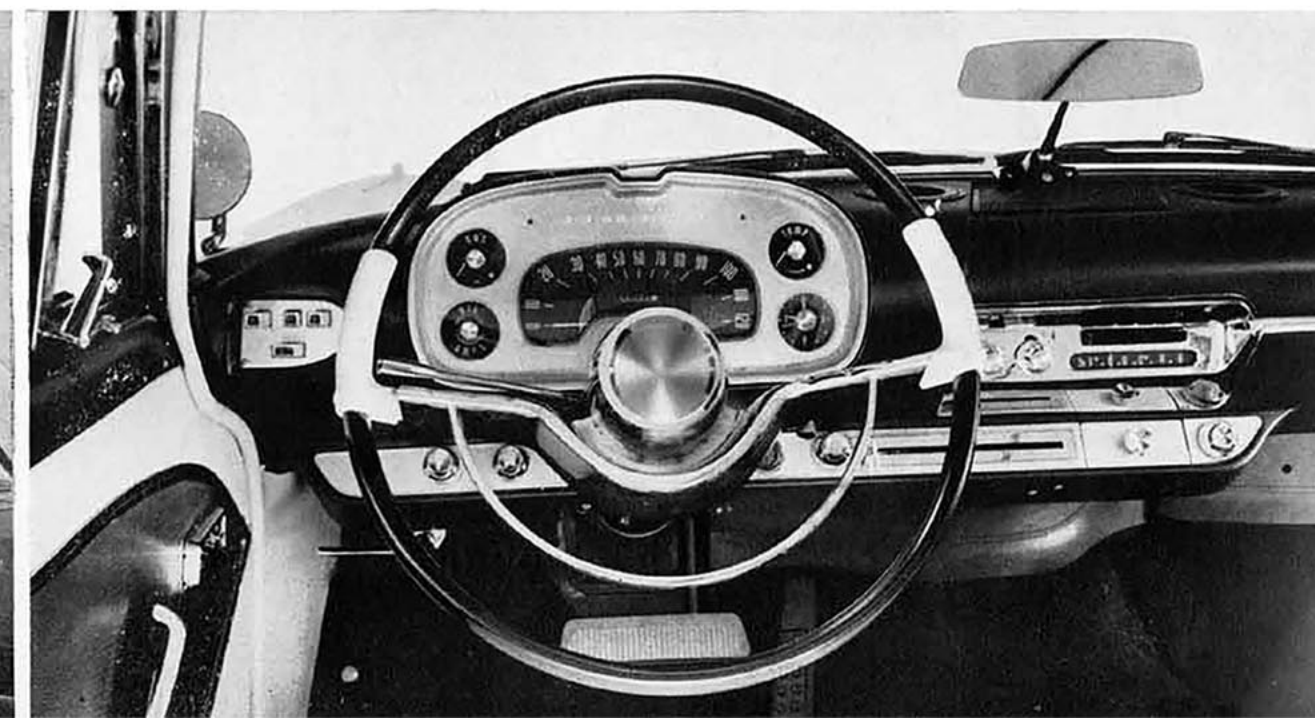

# SPECIFICATIONS

## V-8 MODELS

**ENGINE TYPE:** New, bigger displacement, high-compression Fury "301" V-8 with overhead valves. 301 cu. in. 3.91 bore, 3.13 stroke. Higher (8.5 to 1) compression ratio. New automatic choke. New spool-type rubber shear engine mounts. New, quiet, quick lift camshaft. Adjustable valve tappets. The Fabulous Fury "301" is available in Belvedere, Savoy and Suburban V-8 models. Plaza models available with improved 277 cu. in. V-8 engine. Fury "301" engine with PowerPak on all models, at moderate extra cost. **FUEL SYSTEM:** Dual-filtration includes new, woven plastic fuel filter in gas tank and new extra-fine ceramic filter at carburetor. **FUEL CAPACITY:** 20 gallons. **LUBRICATION:** Full pressure to all crankshaft, camshaft, and connecting rod bearings and to valve rocker arms and tappets. Rotor-type oil pump. Shunt-type oil filter (standard on most models). **COOLING SYSTEM:** Higher capacity, high pressure (14 psi) system. Full-length water jackets. Water pump with ball bearings.

## POWERFLOW 6 MODELS

**ENGINE TYPE:** 6-cylinder L-head valve arrangement. Increased compression ratio (8 to 1). Automatic choke. Redesigned 3-point engine mounting. Counterbalanced crankshaft with 4 main bearings. Chain driven camshaft. Aluminum alloy pistons. Top compression ring chrome-plated. Adjustable valve tappets with heat-resistant alloy steel exhaust valve seat inserts. **FUEL SYSTEM:** New, woven plastic fuel filter in gas tank. **FUEL CAPACITY:** 20 gallons. **LUBRICATION:** Full pressure to all crankshaft, camshaft and connecting rod bearings. Rotor-type oil pump. By-pass type oil filter (standard on most models). **COOLING SYSTEM:** Higher capacity, high pressure (14 psi) system. Water pump with ball bearings.

## V-8 AND 6 MODELS

**FUEL SYSTEM:** Aluminum downdraft carburetor. New, replaceable paper element air cleaner. **ELECTRICAL:** 12-volt electrical system. Heavy-duty battery. High capacity, 30 amp. generator with automatic voltage and current control. Ignition-key start switch. Lighting circuit protected with circuit breaker. Trouble-free plastic coated wiring throughout. Resistor-type spark plugs. Automatic mechanical and vacuum spark control. Splash-proof distributor. **BODY SPECIFICATIONS (Except Suburbans):** Wheelbase 118 in. Over-all length 204.6. Over-all width 78.2. **CONSTRUCTION:** All-steel welded, completely rust-proofed and insulated Safety-Body. Box-section reinforcements around window and door openings. Baked enamel finish. **STEERING:** Worm and roller-type steering gear. Idler arm steering linkage for maximum controllability. Ball-joint steering knuckles.

**VENTILATION:** Permanent cowl air intake. Ventilating wings in each front door. New swivel-mounted defrosters (standard with heater) control direction of air flow. **CHASSIS:** Rugged new full-length boxed steel frame with wider frame rails. Five sturdy cross members.

**FRONT SUSPENSION:** Combined torsion bar springs and ball joints. Lower unsprung weight. Wide-angle lower control struts. Rubber isolated pivot mountings. Redesigned Oriflow shock absorbers. **REAR SUSPENSION:** Asymmetric stub spring design. Larger, soft jounce cushioners. Rubber isolated rear springs. **DRIVE:** Hotchkiss drive with hypoid rear axle. **BRAKES:** New, 11" Total Contact brakes. **TIRES AND WHEELS:** New, large volume tires (10% greater air volume). Size 7:50 x 14. Safety-Rim wheels.

## ACCESSORIES

For the ultimate in driving pleasure and safety, ask your dealer about these accessories specially engineered for your new Plymouth.

Push-Button PowerFlite  
Push-Button Torque-Flite 3 Speed Automatic Transmission (V-8 Belvedere and V-8 Sport Suburban only)  
Overdrive  
Safety-Sure Power Brakes  
Full-Time Power Steering  
Push-Button Power Seat  
Push-Button Power Windows  
Plymouth All Weather Air Conditioner  
Fresh-Aire Heating-Defrosting System  
Custom Push-Button Radio  
Luxury Transistorized "Search-Tune" Radio  
Rear Seat Speaker  
Highway Hi-Fi Record Player  
Sweep-Second Electric Watch  
Chrome Bumper Wing Guards  
Wheel Covers  
Safety-Padded Instrument Panel and Sun Visors  
High Performance PowerPak (V-8 only)  
Dual Exhausts  
Locked Storage Compartment (6 passenger Suburbans)  
Solex Tinted Glass  
Undercoating  
Whitewall Tires

The policy of Plymouth Division of Chrysler Corporation is one of continual improvement in design and manufacture wherever possible to assure a still finer car. Hence, specifications, equipment and prices are subject to change without notice.

For specifications of Plymouth Suburbans, ask your dealer for a copy of the Special Plymouth Suburban Brochure. It contains complete information on all the exciting new Suburban features.

 When you drive a **PLYMOUTH** suddenly it's 1960!