

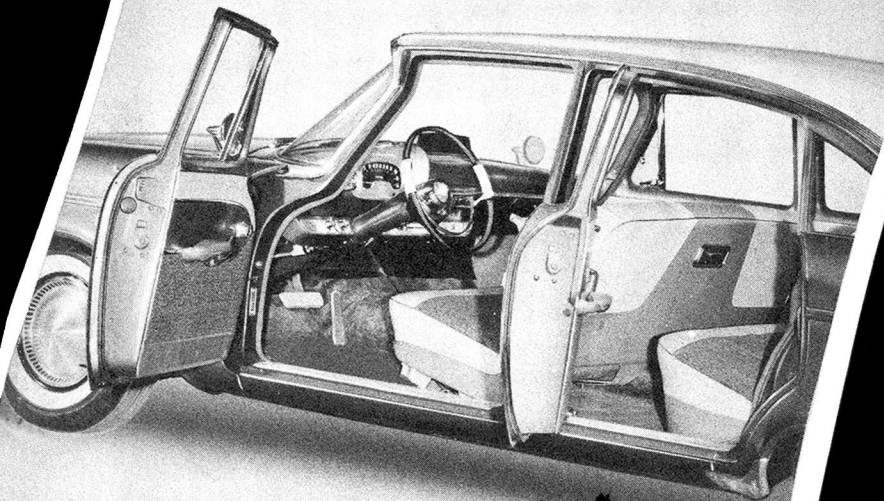

**DOOR ADJUSTMENTS**



**1957 models**





This year we've got a big edge on competition. We not only have the best-engineered cars on the road, we've also got the cars that lead in styling!

Our style-leadership advantage, naturally, is a tremendous help in new-car sales. So, it's up to us in service to maintain this style-edge on competition. Good body work on your part is all it takes to keep us ahead in this respect.

To help you do that, this reference book introduces the latest tips on adjusting 1957-model doors so they will look, work, and seal their best. Here's where you'll locate this vital service information:

	<i>Page</i>
<b>VISUAL INSPECTION</b> .....	<b>4</b>
<b>DOOR ADJUSTMENTS</b> .....	<b>7</b>
<b>STANDARD 4-DOOR SEDAN</b> .....	<b>7</b>
<b>REAR DOOR</b> .....	<b>7</b>
<b>FRONT DOOR</b> .....	<b>9</b>
<b>FRONT FENDER</b> .....	<b>11</b>
<b>DOOR WITH ALUMINUM UPPER FRAME</b>	
<b>REAR DOOR</b> .....	<b>11</b>
<b>FRONT DOOR</b> .....	<b>13</b>
<b>4-DOOR HARDTOP</b>	
<b>FRONT DOOR</b> .....	<b>16</b>
<b>VENT WINDOW FRAME</b> .....	<b>17</b>
<b>FRONT DOOR GLASS</b> .....	<b>17</b>
<b>REAR DOOR GLASS</b> .....	<b>19</b>
<b>2-DOOR HARDTOP</b> .....	<b>20</b>
<b>IMPERIAL DOOR AND GLASS ADJUSTMENTS</b>	
<b>4-DOOR SEDAN</b>	
<b>REAR DOOR</b> .....	<b>21</b>
<b>FRONT DOOR</b> .....	<b>22</b>
<b>HARDTOP MODELS</b>	
<b>REAR DOOR</b> .....	<b>24</b>
<b>FRONT DOOR</b> .....	<b>25</b>
<b>BODY SHIMMING</b> .....	<b>26</b>

# VISUAL INSPECTION

On any new car, it always pays to check door fit carefully before you deliver the car to a customer. In other words, you have to consider the door's *over-all appearance* . . . how easily it *opens and closes* . . . and how well it *seals*. That's always basic. What's more, how the doors fit has a lot to do with the way the entire car looks.



If you find it necessary, adjust the door in its opening to get it *centered* as much as possible. This will improve spacing around the door so that it will be *acceptable*. Acceptable spacing is the first step.

Next, check how the door *operates*. Open and close the door a few times. If the door is fairly well centered, and the striker is properly located, you can tell by the *feel*—and *sound*—how well the door works.

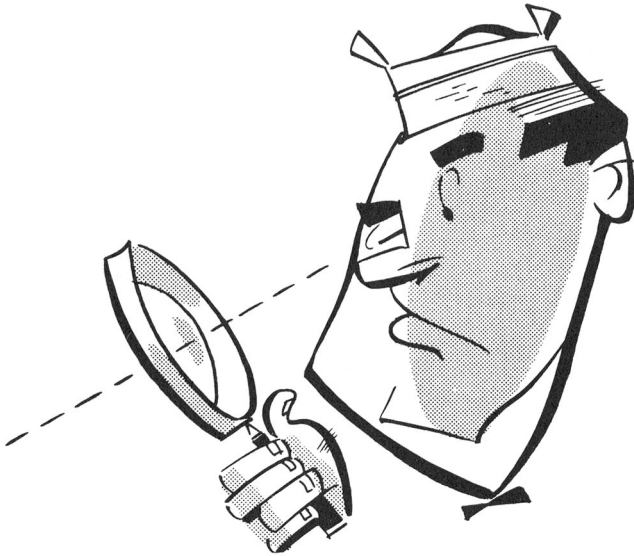

Third, see if the door fits flush with the body panels next to it. Look at the fit; run your hand over the matching surfaces.

Finally, check on how well the door *seals*. When the door is closed, it should put enough compression on the weatherstrip to seal out dust and water. Use a shipping tag for this compression-test part of your inspection.

**Hinge Mounting Permits Door Adjustment.** After your inspection and analysis of what needs to be done, you can get acceptable spacing, good operation, a flush fit, and a good seal by using the adjustments provided by the door hinge mounting. Each door can be moved up, down, fore, aft, in or out—mainly by making hinge adjustments.

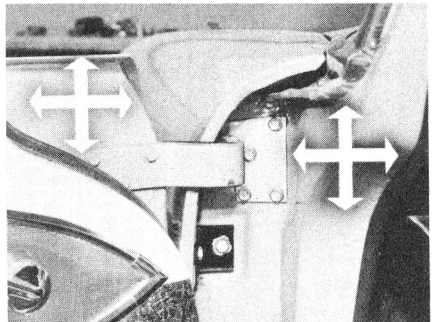

Some mechanics remove the striker when making door adjustment. They say it is easier to fit the door when the striker is out of the way. Later, you can reinstall and adjust the striker.

**Proper Striker Location.** The striker is positioned properly when the door lifts *slightly* so you hardly notice the lift. There should be firm contact between the striker and latch to prevent rattles when the car is driven over rough roads. Be sure to keep the striker in a level plane. If you tip it so it enters the latch at an angle, the door will be hard to open and close.

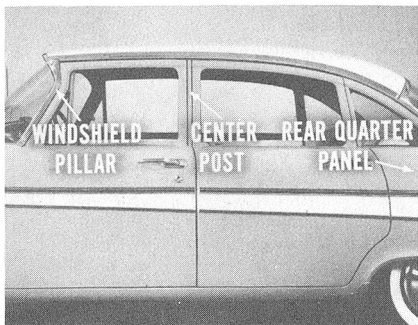

**Reference Points.** When checking over-all appearance, use the rear quarter panel . . . the center pillar . . . and the windshield pillar . . . as reference points. The roof rail and floor sill panels, also, are good top-to-bottom reference points.

Generally, if fore-and-aft adjustments are needed, you'll make them by starting at the rear and working toward the front. You adjust from rear to the front because the rear quarter panel is fixed. You can move the front fender and hood, if it becomes necessary.

Remember that moldings at the windshield pillar and drip rail can be misleading. If they are out of line, or improperly attached, they can make a good door fit look bad. In some cases you can improve appearance merely by adjusting molding alignment.

# DOOR ADJUSTMENTS

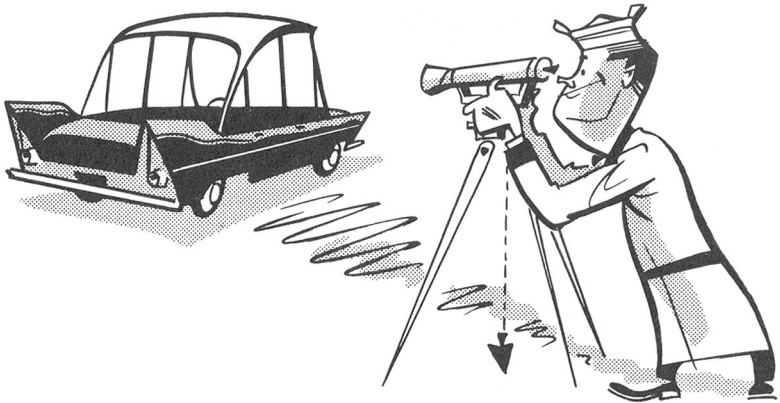

## STANDARD 4-DOOR SEDAN

**Rear Door—Up-or-Down Adjustment.** If you want to raise or lower the rear door of a standard 4-door sedan, first scribe around both hinges on the door face. This line is your guide to show how far you have moved the door.

Then, to control movement, place a jack under the forward edge of the door, as close as you can to the hinge pillar. A cloth-covered wooden block will protect the finish. Also, keep the block on the lower face (inside the flange) of the door.

Loosen the mounting bolts on both hinges about  $\frac{1}{4}$  to  $\frac{1}{2}$  a turn . . . just enough for controlled movement. With the jack, raise or lower the door as needed, and retighten the bolts.

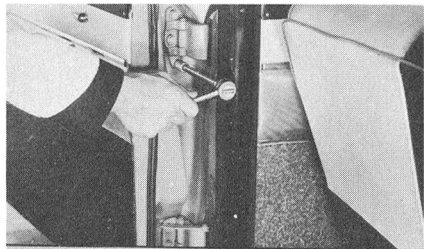

LOOSEN  $\frac{1}{4}$  TO  $\frac{1}{2}$  TURN  
FOR CONTROLLED MOVEMENT

Close the door. Check the fit. You can get a little more up and down movement, if necessary, by loosening the hinges inside the hinge pillar. Then, readjust the striker.

**Rear Door—Fore-and-Aft Adjustment.** To adjust the rear door fore or aft, remove the trim at the center pillar and scribe around the hinge

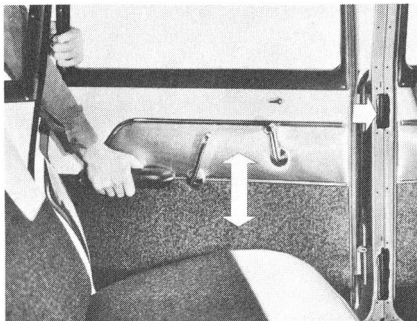

positions. Then, to move the *upper part* of the door fore or aft, loosen only the *upper hinge bolts* at the pillar. Open the door a few inches. Lift the rear door edge, or pull down on the rear edge—depending on which way you want to go. Retighten the bolts you loosened.

**CAUTION:** When an adjustment requires loosening the hinge bolts of only *one* hinge, you want to be careful about causing a strain on the opposite hinge. When the adjustment has been completed, and the bolts tightened, *always* loosen the bolts in the opposite hinge to permit it to align itself to the new position of the hinge which has just been moved.

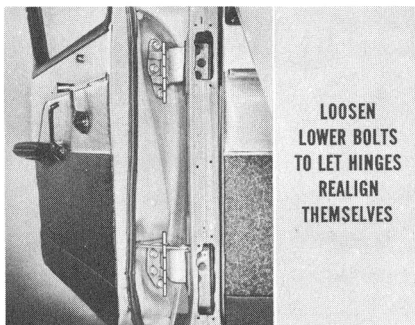

Then, retighten the bolts. A straight hinge-pin line is important, or you'll end up with a heavy-dragging door. It will help to swing the door a few times to be sure you've eliminated any bind caused by the hinge pins being cocked.



To move the *lower part* of the door fore or aft, loosen only the *lower hinge bolts* at the pillar. Open the door a few inches and pull down at the rear edge, or lift up as needed. Retighten the bolts. Then, loosen the upper hinge bolt to let the hinge realign itself, and retighten the bolts.

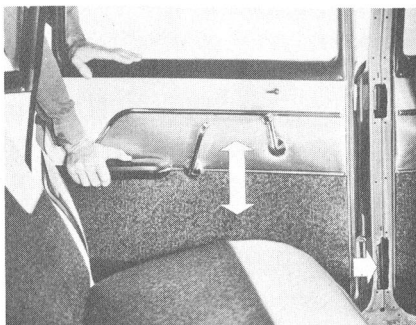

**Rear Door—In-or-Out Adjustment.** Moving the door in or out to get a flush fit is also provided for by the hinge design. For example, to move the *upper half* of the door in or out, you loosen only the bolts at the *upper hinge*. With your hand, you then move the door as required. Retighten the bolts to hold this adjustment. Loosen the *lower hinge* if you want to move the *lower half* of the door. Then, relocate the striker plate.

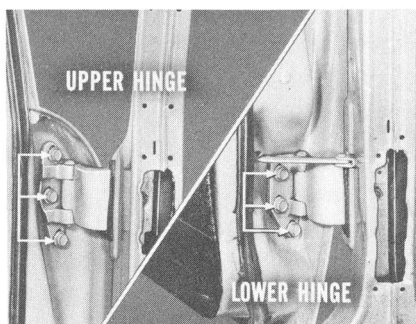

**Front Door—Up-and-Down Adjustment.** Mark the hinges at the front pillar. Then, with the covered wooden block and jack, support the opened door. Also, loosen the attaching bolts of both hinges at the hinge pillar just enough to control movement. Raise or lower the jack to raise or lower the door. Tighten the attaching bolts and check the fit. Some additional vertical adjustment is possible by loosening the bolts that hold the hinge to the door. Last, check striker adjustment and change it if needed.

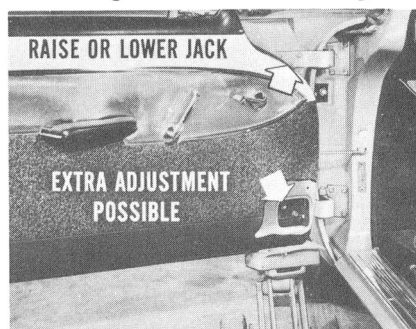

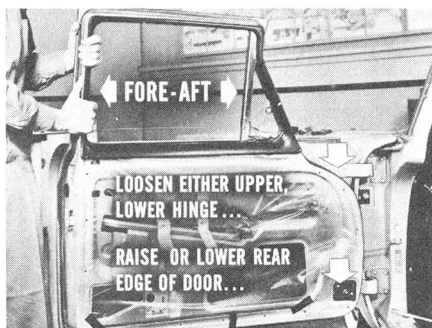
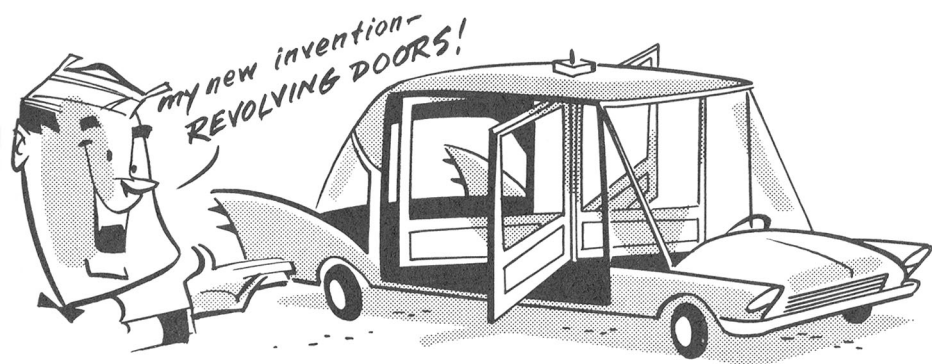

**Front Door—Fore-and-Aft Adjustment.** For fore-and-aft movement, you loosen either the upper or lower hinge. (*Upper to move the upper part. Lower to move the lower part.*) Then, you raise or lower the rear edge of the door, just as you did the rear door.

**Front Door—In-or-Out Adjustment.** To move the front door in or out, loosen either the upper or lower hinge at the pillar, depending on whether the upper or lower part of the door is to be moved. Open the door *fully*, and lift or pull down on the door to get the movement needed. Retighten the hinge you loosened. Loosen the opposite hinge to align the pins, and then retighten it. After any major door movement, of course, it is usually necessary to adjust the striker for a uniform flush fit at the rear edge of the door.

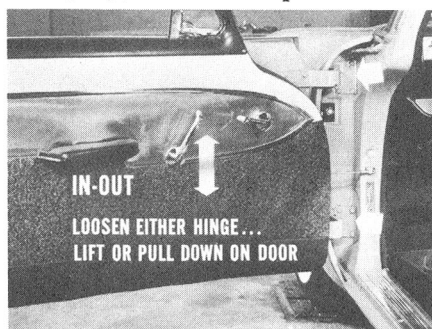

**Front Fender Adjustment.** If you discover that you have to move the front fender to improve a flush fit or the spacing, you can loosen the top fender bolt. This lets you move the fender in or out. At this point also, you can insert shims to raise the upper rear corner to get it flush with the door surface at the cowl. Other fender-to-cowl bolts can be loosened to move the entire fender fore or aft, if you should find it necessary.

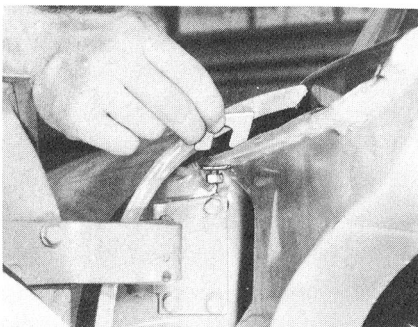

## DOOR WITH ALUMINUM UPPER FRAME

Since the hinge and striker design's the same, adjustments at those points are made the same way on all our 1957 models. Just line up the doors with adjacent body panels by shifting the hinge mountings.

As you know, the 4-door sedan models of Imperial, Chrysler (except Windsor) and De Soto (except Firesweep models) use a newly designed door having an extruded aluminum upper frame. These aluminum door frames permit additional adjustments to get a better fit at the upper half of the doors, if necessary.



**Rear Door Adjustment.** On cars with the aluminum frame doors, you start your door adjustments with the *rear door*. You'd make hinge adjustments to fit the door to the opening, and then check the fit and seal above the belt line.

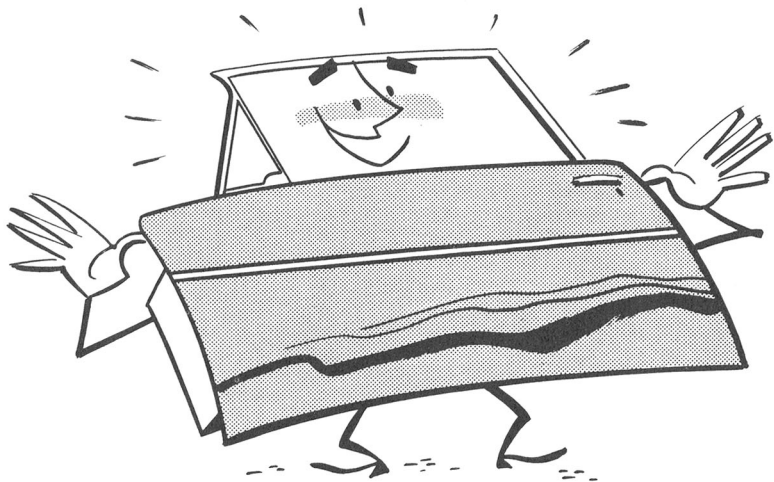

To adjust the frame in or out to get a better fit against the roof rail, loosen the four frame mounting bolts first. You reach these

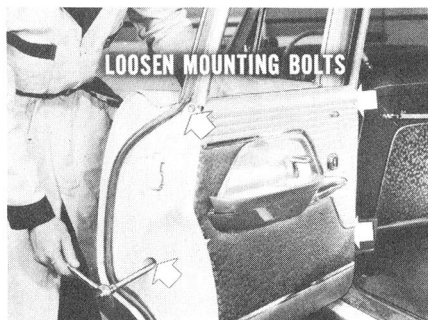

through holes in the front and rear face of the door. (On Imperial models, loosen the weatherstrip on the rear face of the door to uncover the upper bolt.) Then, raise the glass all the way. Move the frame in or out, and tighten the bolts. Last, check the fit.

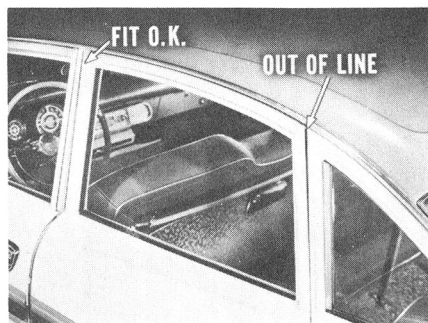

Now, just as an example, if the fit along the front edge is okay, but the rear edge is slightly out of line, you don't have to loosen all four bolts. Loosen only the two rear mounting bolts. Then, readjust the frame for a good fit at the rear edge.

**CAUTION:** *Never bend* the aluminum frame to get a good fit. Use only the movement provided by the frame mounting bolts to get proper adjustment.

Here's another point worth keeping in mind. Take it easy when you tighten those frame mounting bolts. You see, they thread into steel inserts which are spun into the aluminum frames. So, don't draw them up so tight that the inserts will loosen up.

**Front Door Adjustment.** To adjust the front door vent window and glass frame, first remove the trim. Then, loosen the five aluminum frame mounting bolts and the lower division bar attaching bolt inside the door. You get at the division bar bolt through the large access hole in the inner panel.

Remember . . . once the attaching bolts are loose, you should *raise* the glass. Then, push the frame in or out as needed for a good fit around the window opening. Tighten all bolts except the one at the division bar, and check the fit.

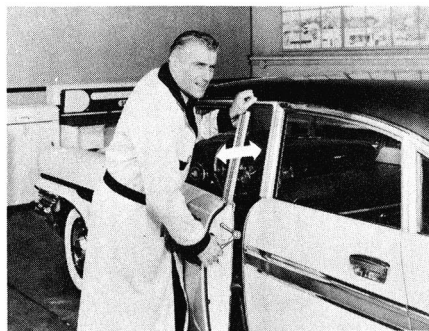
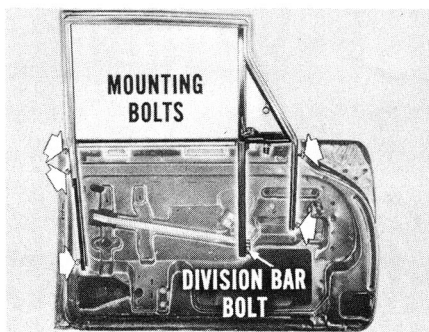
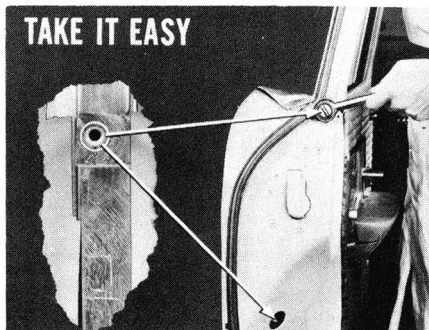



As you did on the rear door, if one edge fits well, but the other edge is out of line, loosen just the bolts on that edge. Then readjust that edge and tighten the bolts you loosened, along with the bolt at the division bar.

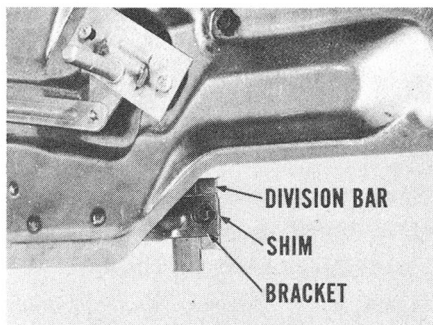

Finally, check operation of the glass. Run the glass up and down. If it binds at the lower end of the division bar, remove the mounting bolt at the lower end. Shim between the bar and its bracket to get smooth window glass operation.

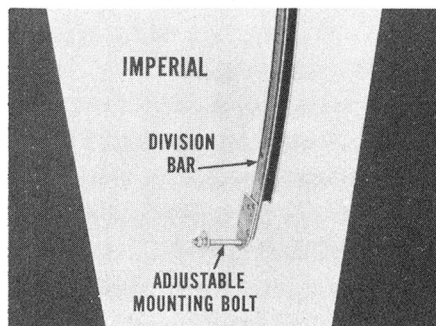

On Imperial models, an adjustable mounting bolt at the lower end of the division bar provides an in-and-out adjustment. No shims, therefore, are needed.

By the way, if you should happen to remove any of the aluminum frame attaching bolts, be sure to get the *right length* bolt in the right place. A bolt that's too long could enter the channel and interfere with glass operation.

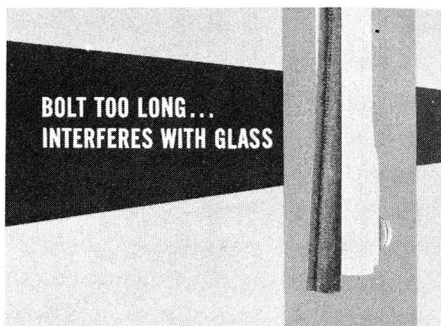

Another point to watch is that miter joint at the top of the aluminum frame. If the flange of the frame is sprung outward, the miter joint will open up on the outside. This affects sealing as well as appearance. You can correct a case like this by using a block of wood and mallet to tap the flange down at the corner until the joint closes up.

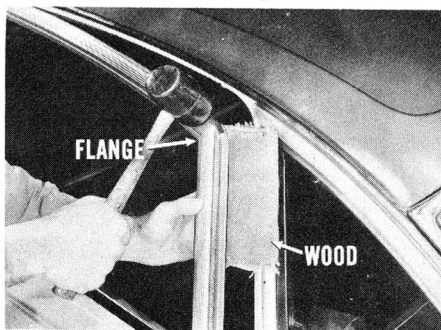

On that aluminum trim strip at the center pillar, too, you may have to use a drift, and shift the flange to improve appearance. In addition, be sure there's enough clearance between the lower end of the trim strip and the front door panel.





#### 4-DOOR HARDTOP DOOR ADJUSTMENTS

On 4-door hardtops, you start door and glass adjustments at the *front* and work your way to the *rear*. That's because there's less adjustment possible between the front vent window and windshield pillar. There's much more adjustment available at the rear, due to the new rear door design.

**Front Door.** You adjust the front door the same way you adjust front doors on other models, to get a good door fit first. Hinges and striker are the same. But at the top edge of the front vent frame—where it seals at the roof rail weatherstrip—you'll have to exercise extra care.

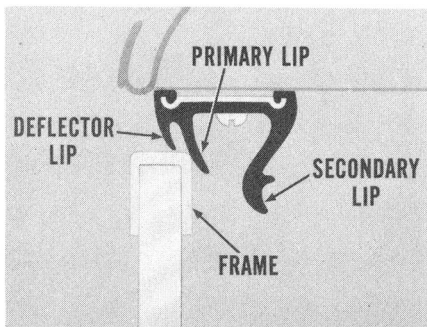

The weatherstrip at this point has three sealing lips: an outside deflector lip; a primary sealing lip; and, a secondary sealing lip. As the door is closed, the glass frame should just clear the outside lip.



In other words, the frame should put enough pressure on the primary lip for a good seal. So, adjust the top edge of the frame to make it lean into the body for a good secondary seal at the third lip.

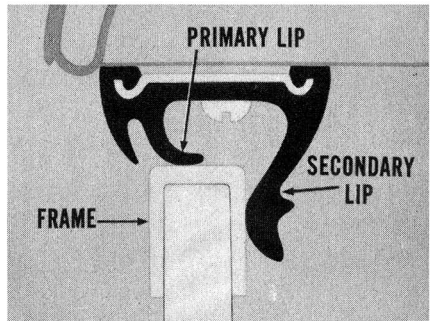

**Vent Window Frame Adjustment.** You can adjust the vent frame and division bar assembly in or out at three attaching points. You'd first loosen the upper frame attaching bolt. You reach this bolt from the front face of the door.

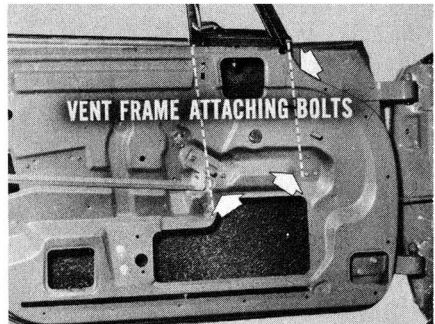

Next, loosen the lower frame attaching bolt at the bracket inside the inner panel. Then, loosen the bolt that holds the lower end of the division bar to its bracket inside the door.

Finally, move the frame in or out for a good fit and seal. Tighten the three attaching bolts and check the over-all fit by opening and closing the door.

**Front Door Glass Adjustment.** Raise the front door glass and see if it forms a straight line with the top edge of the vent frame. If you need to level the glass, you'll find it easy to do.

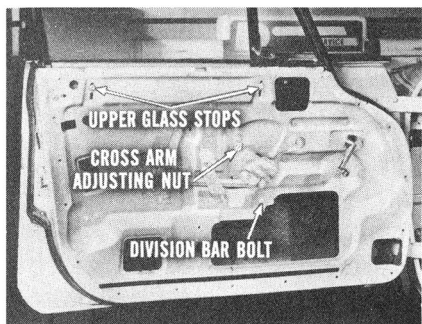

First, loosen the cross-arm pivot shaft nut and the upper glass stops. Next, loosen the small bolt that holds the division bar bracket.

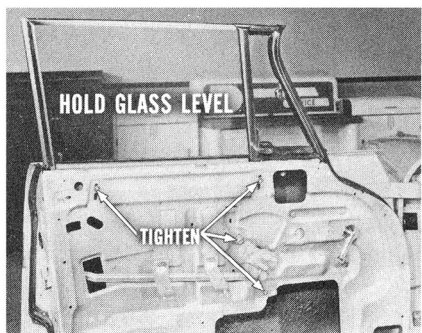

Raise the glass all the way, and shift it by hand so the top edge is level. Hold it in that position, and retighten the bolt, the pivot shaft nut, and the upper glass stops. Check glass operation again. If it runs too tightly, or too loosely in the channels, you'll have to adjust the rear channel.

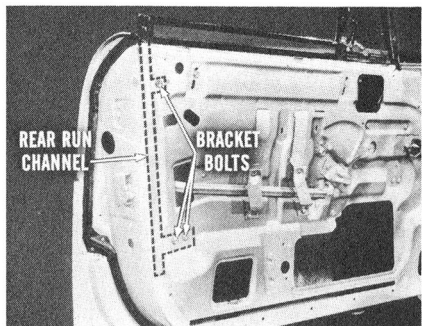

You do this by loosening the bolts of the two brackets that hold the rear run channel. Lower the glass and shift the rear channel forward until it makes even contact with the rear edge of the glass. Then, tighten the brackets to hold the adjustment.

For an in-or-out glass adjustment at the rear edge of the door, loosen the two rear run-channel-to-bracket attaching bolts. You reach these bolts from the rear face of the door. Move the glass in or out as needed. Tighten the rear channel bolts. Check glass fit at the weatherstrip by opening and closing the door.

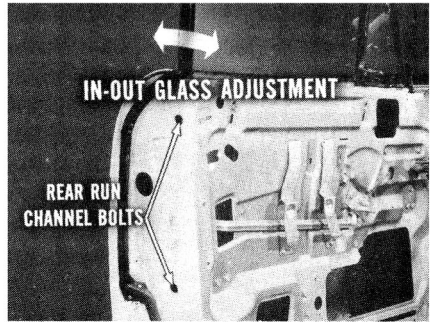

**Rear Door Glass Adjustment.** You probably know how to make this adjustment. However, as a reminder, you loosen the front channel adjusting bolts to provide any up-and-down movement required. That's also the best way to level the glass in its opening.

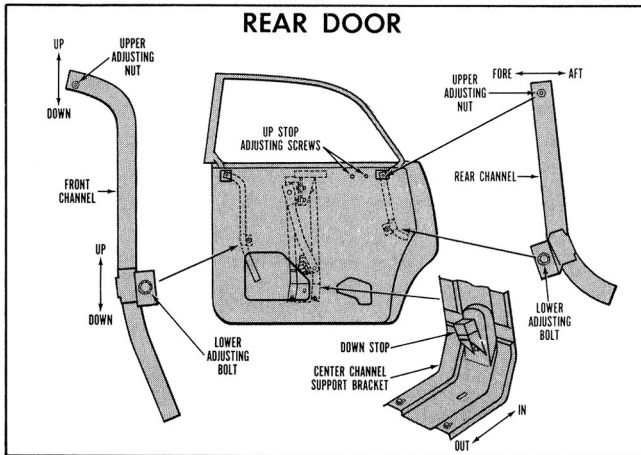

You loosen the rear run channel bolts for any fore-and-aft movement needed. And, for in-and-out adjustment of the glass, you loosen the center channel support bracket bolts. Tighten the bolts when you get the glass in or out as much as is needed. Finally, adjust the upper stops to control the amount of rear door glass travel that's necessary.

Incidentally, if the upper glass stop restricts glass travel, loosen the two upper stop screws. Run the glass up to match the glass height of the front door glass. Then position the upper stop to limit travel at that height, and tighten the stop screws.

**Rear Glass Loose at Rear Edge of Front Door**—If the front edge of the rear glass does not fit tightly against the rear edge of the front glass, loosen the rear channel upper attaching nut and the rear channel

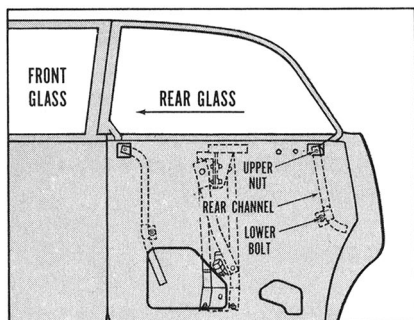

lower attaching bolt. Adjust the rear channel fore or aft until you get a good seal at the rear edge of the front door. Tighten the upper rear channel nut to hold this adjustment. Then, lower the glass, and tighten the rear channel lower attaching bolt.

After any adjustment on the rear door, always check glass operation. Lower and raise the

glass. If there is any bind, loosen the front channel lower attaching bolt. Lower the glass so that the nylon roller on the glass frame will move the channel into alignment. Then, tighten the front channel attaching bolt. Recheck smoothness of glass operation.

Also, adjust the glass lower stop—inside the inner panel—so the top edge of the glass is flush with the top edge of the door panel when the glass is fully lowered. This is an important appearance adjustment.

## **TWO-DOOR HARDTOP MODELS**

On these models, door and glass adjustments are made very much like those on the 4-door hardtops. Rear quarter glass adjustment is made the same as rear door adjustments on the 4-door hardtops. Remember to remove the rear quarter inside trim, however, to get at the adjusting screws and bolts. Front door adjustments are handled the same as for 4-door hardtops.

At the roof rail on two-door hardtops, the weatherstrip is a little different. The section of weatherstrip that forms the seal for the rear quarter window is a channeled section. The quarter glass runs *inside* the channel instead of sealing against a lip as at the front door.

## IMPERIAL DOOR AND GLASS ADJUSTMENTS

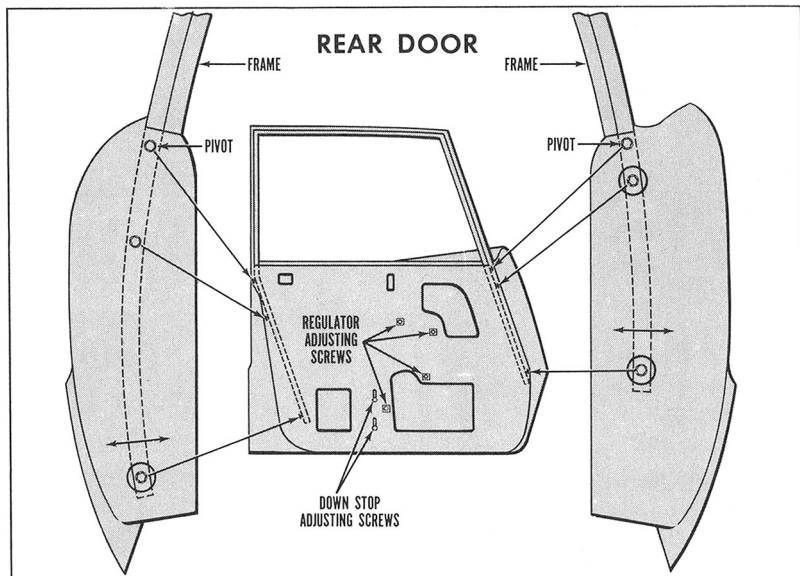

**4-Door Sedan Rear Door.** Because of the curved glass on these models, aluminum frames are also curved. Five frame mounting bolts—two at the rear, and three at the front—are used. You reach them from the faces of the door without removing any trim. To improve the fit and seal above the belt line, you can loosen these mounting bolts. Then, move the frame in or out and retighten the bolts.

**Glass Adjustment.** Check glass operation. If it doesn't raise or lower smoothly, or is cocked in the channels, loosen the four regulator and power unit assembly attaching screws. Shift the entire assembly to realign the glass and retighten the screws. Recheck operation.

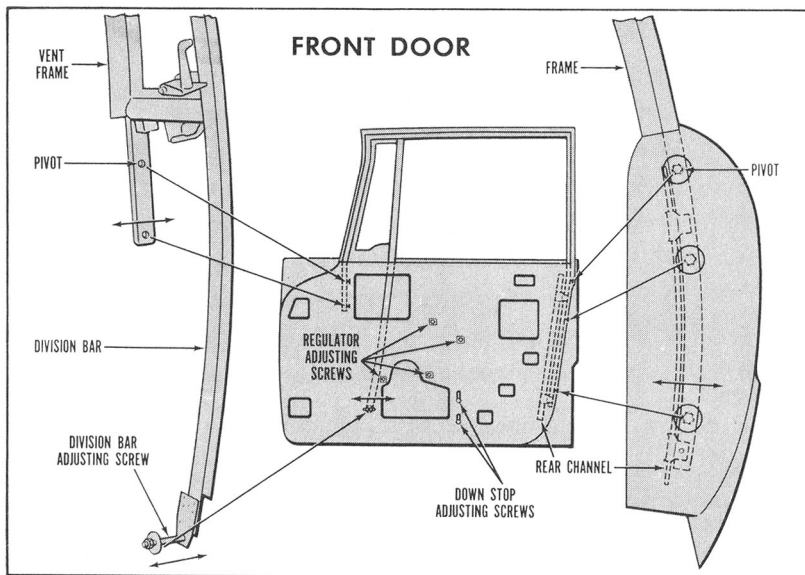
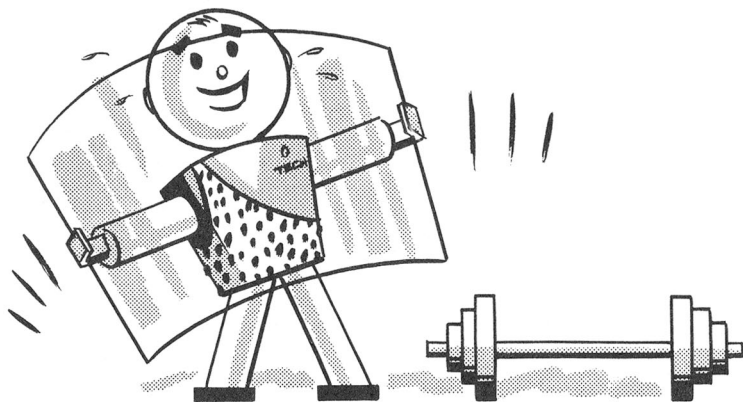

**Front Door.** Notice that the rear edge of the glass doesn't follow a conventional run channel course as the glass is lowered. A nylon roller at the rear of the glass frame follows a curved, box-type metal channel instead. This rear channel is attached to the rear leg of the

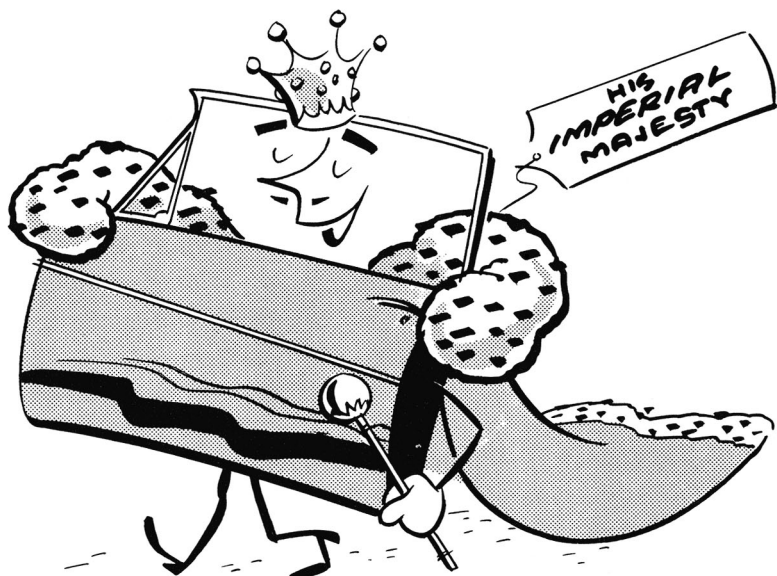

aluminum frame. Whenever you move the frame, you also adjust the rear channel. To tip the rear leg of the frame in or out, loosen the three frame mounting bolts at the rear face of the door; adjust and then retighten.

At the vent wing, a curved division bar acts as the front run channel. You can move the lower end of the division bar in or out by loosening the lock nut on a special adjusting screw. Turn the screw to pull or push the division bar in or out. Then, retighten the lock nut to hold the adjustment.

An elongated hole at that point also provides fore-and-aft adjustment of the division bar. This will help you adjust for a loose or tight fit between the front glass edge and division bar channel. The front leg of the frame is attached to a bracket inside the inner panel. You can reach this through an access hole at the upper front part of the door. Mounting bolts, in elongated holes, allow for an in-or-out adjustment of the frame at the front.

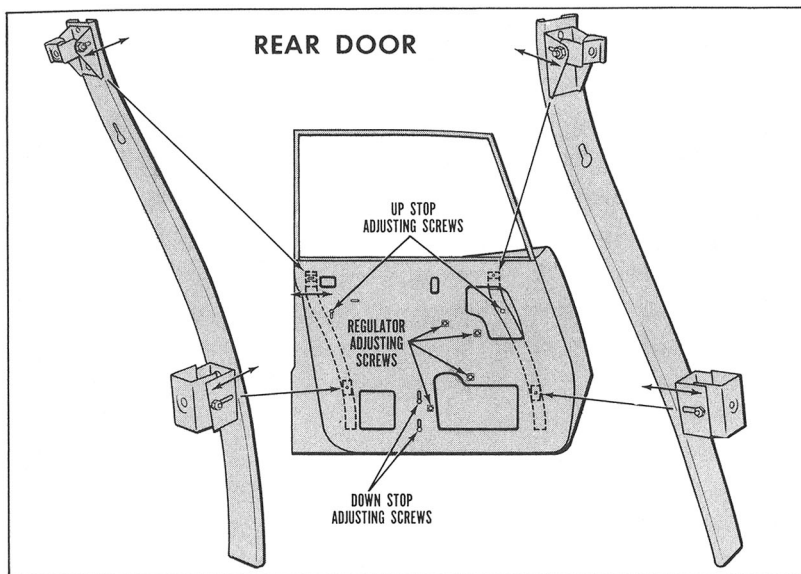

## IMPERIAL HARDTOP MODELS (SOUTHAMPTON)

**Rear Door.** There is no center support and guide channel on this as on other hardtop models. Instead, curved, box-type front and rear channels, plus a scissor-type regulator, guide and support the glass. You can adjust the rear run channel in or out at either top or bottom end. At both points, bolts and nuts attach the channel to brackets inside the door. Moving the channel in or out also adjusts the rear edge of the glass in or out.

You adjust the front channel in or out in the same manner. You can also adjust the upper bracket fore or aft to move the leading edge of the glass for a good fit at the trailing edge of the front glass.

To control glass fit at the roof-rail weatherstrip, loosen and tighten the screws at two upper stops. Lower stops can also be adjusted to level the glass with the sill when the glass is fully lowered.



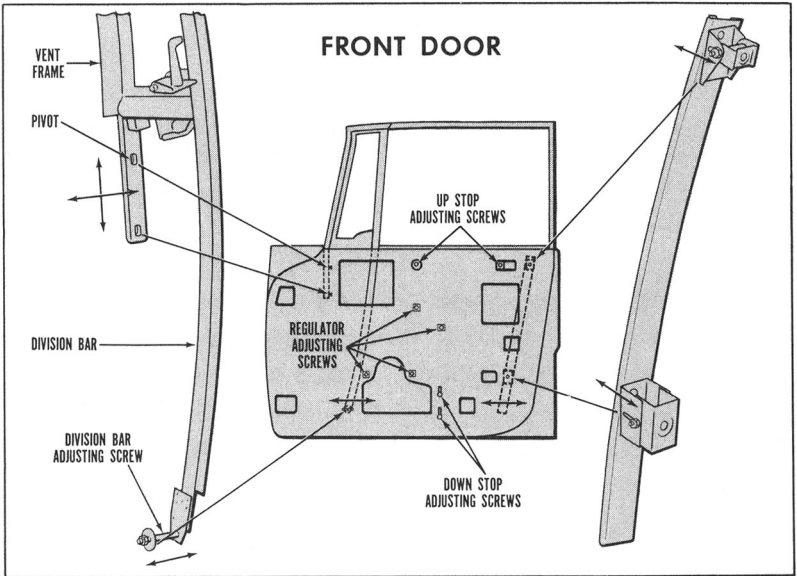

**Front Door.** You handle this similar to front door adjustments on the Imperial 4-door sedan model. Vent frames have the same adjustment at the bottom of the division bar. The front leg of the vent frame is attached by two bolts inside the inner panel. Elongated holes allow for any in-or-out adjustment necessary. You can also move the division bar in or out to tip the frame when needed. In addition, you can shift the division bar fore or aft to get a good fit between the front run channel and leading edge of the glass.

At the rear of the front door, a box-type steel channel can be moved in or out at the top or bottom to tip the glass as needed. You can also adjust the lower channel bracket fore or aft to level the top edge of the glass.

To improve glass operation if necessary raise the glass and loosen the four regulator and power-unit assembly screws. Shift the regulator as needed to level the glass and smooth out operation. Finally, loosen and adjust the two upper stops for proper glass travel.

# BODY SHIMMING

Once in a great while, you may find it hard to get enough door movement to fit the door properly. In a case like this, you may have to check the shimming at the body bolts. There just might be a slight misalignment of the body on the frame, and, as a result, some misalignment of the door opening.

Remember that proper tightening at the body bolts affects body and door alignment. If you think body bolts are loose, raise the car and check compression of the rubber insulators at the body bolts. Uneven compression is a sign of uneven torque. Right and left front body bolts have no insulator. They are solid mounts.

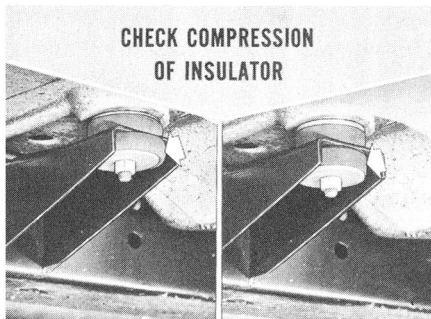

Body bolts should be torqued to 18 foot-pounds. But before you check this, make sure the nut turns freely on the bolt so you'll get a true reading on the torque wrench.

If the opening is not square with the door, and proper tightening of the bolts does not correct it, you may have to add or remove the



shims at the body bolts. If you find that you do have to add or remove shims, loosen all the body bolts on the side you're working on. And, after adding shims at any bolt, shim the adjacent bolts if you find it's needed to keep the body supported evenly on the frame.

Another thing, when you add shims, run the nuts up slightly and check over-all door fit and alignment. Then, finally tighten all body bolts to the specified 18 foot-pounds.

## GOOD DOOR ADJUSTMENTS PAY DIVIDENDS

Every good technician knows how many doors most of us open and close dozens of times each day. And nobody needs to tell you which doors are remembered. Unfortunately, they're the doors that opened *hard*, *stuck*, or *didn't fit* properly.

Since door adjustment is so much in the public eye and mind, good work on your part will pay off in customer satisfaction. When you can put your finger on the cause of an improper fit and correct it promptly, the customer's respect for you will grow. He'll continue to bring his service business your way because he knows you can deliver the goods.



**RECORD YOUR ANSWERS  
TO THESE QUESTIONS  
ON QUESTIONNAIRE NO. 110**

By just making hinge adjustments you can move each door up, down, fore, aft, in, or out as needed.  RIGHT 1  WRONG

A properly located striker lifts the door slightly and still makes firm contact with the latch to prevent noise.  RIGHT 2  WRONG

On 4-door sedans, make fore-and-aft adjustments by starting at the rear and working toward the front of the car.  RIGHT 3  WRONG

If necessary, move the rear quarter panel to align the rear door.  RIGHT 4  WRONG

When moving doors, loosen mounting bolts on both hinges  $\frac{1}{4}$  to  $\frac{1}{2}$  a turn to maintain control of the adjustment.  RIGHT 5  WRONG

After adjusting one hinge, loosen the opposite hinge so the hinge pins will realign themselves and prevent binding.  RIGHT 6  WRONG

Loosening the front fender upper rear bolt lets you move the fender in or out to improve a flush fit or the spacing at that point.  RIGHT 7  WRONG

Hinge and striker adjustments are made differently on each body style of the 1957 models.  RIGHT 8  WRONG

Start door and glass adjustments at the front and work toward the rear when working on four-door hardtop models.  RIGHT 9  WRONG

When adjusting the aluminum frame on the Chrysler and De Soto doors, always keep the window down to reduce breakage.  RIGHT 10  WRONG